

Hygeaire®

ULTRAVIOLET INDIRECT AIR DISINFECTION

Model LIND30-EVO

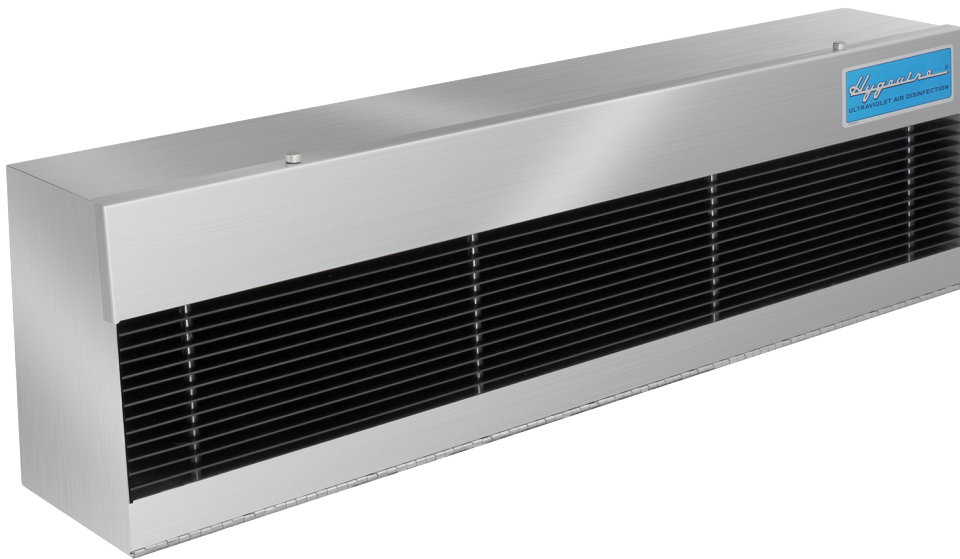

Owner's Manual

Installation, Operation & Maintenance

Read and Follow All
Safety Instructions.
Save These Instructions.

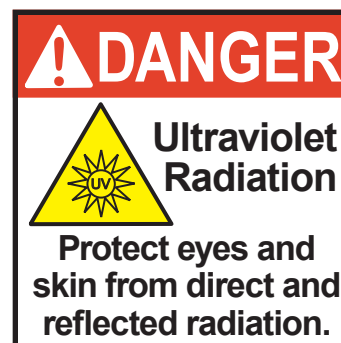

ATLANTIC  **ULTRAVIOLET**
CORPORATION®

SINCE 1963

Manufacturers / Engineers / Sales / Service
Germicidal Ultraviolet - Equipment & Lamps

375 Marcus Boulevard • Hauppauge, NY 11788
631.273.0500 • Fax: 631.273.0771
Email: Sales@AtlanticUV.com
Ultraviolet.com • BuyUltraviolet.com

Extensive Product Information Available at:

Ultraviolet.com
Buyultraviolet.com



TABLE OF CONTENTS

SAFETY WARNINGS	3
SAFETY INSTRUCTIONS	3
SAFETY LABELING	3
CAUTION	3
PRODUCT APPLICATION	4
CONSTRUCTION	4
PRINCIPLE OF OPERATION	4
LIMITATION OF USE.....	4
UNPACKING	4
INSTALLATION	5
FIXTURE PLACEMENT	5
SETUP INSTRUCTIONS	5
ULTRAVIOLET OUTPUT ADJUSTMENT	5
PRECAUTIONS.....	5-6
INSTALLATION OF LIND30-EVO	6
MAINTENANCE	7
LAMP INSTALLATION, REPLACEMENT, OR CLEANING.....	7
QUARTZ BREAKAGE.....	8
DISPOSAL OF MERCURY ADDED LAMPS.....	8
TROUBLESHOOTING	8
TECHNICAL SPECIFICATIONS	8
REPLACEMENT PARTS	9
FIGURE 2 – REPLACEMENT PARTS FOR MODEL LIND30-EVO	9
TABLE 3 – REPLACEMENT PARTS FOR MODEL LIND30-EVO	9
OPTIONAL ACCESSORIES	10
MAINTENANCE NOTES	10-11
USER ASSISTANCE	12
PATENT NOTICE.....	12
WARRANTY & PRODUCT REGISTRATION	12

These instructions generally describe the installation, operation and maintenance of the **Hygeaire®** Indirect Germicidal Ultraviolet Air Disinfection Fixture, Model LIND30-EVO. Questions that are not specifically answerable by these instructions should be directed to the factory.

Atlantic Ultraviolet Corporation® takes all possible precautions when packaging equipment to prevent damage. Carefully inspect and report all damages. Do not install damaged equipment. Follow all instructions on any labels or tags. Carefully inspect all packing materials before discarding to prevent the loss of accessories, mounting hardware, spare parts or instructions.

The information and recommendations contained in this publication are based upon data collected by the Atlantic Ultraviolet Corporation® and are believed to be correct. However, no guarantee or warranty of any kind, expressed or implied, is made with respect to the information contained herein. Specifications and information are subject to change without notice.





SAFETY WARNINGS

- All personnel should be alerted to the potential hazards indicated by the product safety labeling on this unit.
- The following conventions are used to indicate and classify precautions in this manual and on product safety labeling. Failure to observe precautions could result in injury to people or damage to property.

 This is the safety alert symbol. It is used to alert you to potential personal injury hazards. Obey all safety messages that follow this symbol to avoid possible injury or death.

 **DANGER** Danger indicates an **IMMINENTLY** hazardous situation, which, if not avoided, **WILL** result in death or serious injury.

 **WARNING** Warning indicates a **POTENTIALLY** hazardous situation, which, if not avoided, **COULD** result in death or serious injury.

 **CAUTION** Caution indicates a **POTENTIALLY** hazardous situation, which, if not avoided, **MAY** result in minor or moderate injury.

 **CAUTION** Caution used without the safety alert symbol indicates a potentially hazardous situation, which, if not avoided, may result in property damage.

 This symbol is used to identify an **ELECTRICAL SHOCK** or **ELECTROCUTION** hazard.

 This symbol is used to identify an **ULTRAVIOLET LIGHT** hazard.

 This symbol is used to identify the need to wear approved ultraviolet blocking eyewear.

 This symbol is used to identify the need to wear approved ultraviolet blocking face shield.



 This symbol is used to identify the need to wear protective gloves.



 This symbol is used to identify components which must not be disposed of in trash

SAFETY INSTRUCTIONS

 **WARNING** To guard against injury, basic safety precautions should be observed, including the following:

1. Read and follow **ALL** safety instructions.

   **WARNING** Avoid exposure to direct or reflected germicidal ultraviolet rays. Germicidal ultraviolet rays are harmful to the eyes and skin.

2. Intended for indoor use only.
3. Do not alter design or construction.
4. Do not use this unit for other than its intended purpose, as described in this manual.
5. Do not mount under any source of moisture or condensation, such as humidifiers, cooling coils, etc.
6.  **CAUTION** Germicidal ultraviolet rays may break down plastic, rubber or other non-metallic materials, with inadequate resistance to ultraviolet. Shield all plastic, rubber or other non-metallic parts such as; plastic drain pans, wire insulation, flex ducts, humidifiers, filters, etc. which may be exposed to direct or reflected germicidal ultraviolet rays.
7. Do not remove any labels or devices.
8.  **WARNING** Do not operate without proper electrical ground.
9. Do not operate the unit if there is visible or suspected damage to the unit or, if applicable, there is damage to power cord and/or plug.
10. Do not operate without lower panel secured.
11. Utility power supplied, to the unit, **MUST** match power requirements listed on the unit label.
12.  **WARNING** Always disconnect power to the unit before performing any service or maintenance.
13. Read and follow all notices and warnings on the unit.
14. **SAVE THESE INSTRUCTIONS.**

SAFETY LABELS

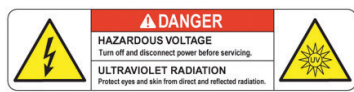

Danger Label: Hazardous Voltage and Ultraviolet Radiation (00-0199A1)



Location of Danger Label

CAUTION

It is the user's responsibility to determine and validate the suitability of this equipment for use in the user's system or process.

No warranty or representation is made by the manufacturer with respect to suitability or performance of this equipment or to the results that may be expected from its use.

The user should periodically inspect, clean as necessary and confirm the presence and good legibility of the product safety labels. Contact the factory for replacement labels in the event that any of the labels are missing or illegible.

PRODUCT APPLICATION

CONSTRUCTION

The **Hygeaire**[®] brand fixtures are categorized as indirect type germicidal ultraviolet fixtures, which utilize **STER-L-RAY**[®] Germicidal Ultraviolet Lamp with a series of louvers to direct germicidal ultraviolet rays to the upper areas of a room, thereby destroying bacteria and viruses that are carried into the ultraviolet field by convection currents or air circulation.

Each **Hygeaire**[®] fixture is equipped with a **Surelite**[™] Variable Output Ballast which enables on-site adjustment of ultraviolet output.

The **Hygeaire**[®] consists of: a Louver Panel, Parabolic Reflectors with specular aluminum inserts, **Surelite**[™] Electronic Variable Output Ballast, **STER-L-RAY**[®] Germicidal Lamp, and Stainless Steel Housing.

PRINCIPLE OF OPERATION

The **Hygeaire**[®] design has been carefully conceived to provide germicidal ultraviolet rays to disinfect the upper room air of occupied spaces in order to reduce the risk of cross infection and exposure of occupants to infectious airborne microbes.

The dosage, as it applies to ultraviolet disinfection, is a function of time, and the intensity, of ultraviolet radiation, to which the air is exposed. The exposure time, in seconds, is the total time it takes the air to move through the ultraviolet field, produced by the germicidal lamp. Exposure time is related to the airflow rate; the higher the airflow, the lower the exposure time or the lower the airflow, the higher the exposure time.

The operation of the **Hygeaire**[®] is as follows:

1. Ultraviolet rays project across the upper room air.
2. Bacteria and virus are destroyed that are carried into the ultraviolet field by convection currents or air circulation.
3. The air in the room is continuously being purified.

LIMITATION OF USE

Hygeaire[®] requires knowledgeable planning for; location, installation, and continued supervision to prevent exceeding the ultraviolet radiant exposure incident Threshold Limit Value (TLV) set by the American Conference of Governmental Industrial Hygienists. Currently the ultraviolet radiant exposure incident for unprotected skin or eyes should not exceed 0.2 microwatts per square centimeter ($\mu\text{W}/\text{cm}^2$) at 254 nanometers (nm) for an eight (8) hour period.

Hygeaire[®] requires professional installation so all wiring complies with applicable local and national electrical codes. Installation is permanent, and relatively inflexible.

Safety and maintenance procedures **MUST** be implemented to prevent accidental exposure of personnel and other persons who might enter the irradiated space (Electricians and other trades people in particular). All work performed (painting, new ceilings, equipment or fixture installation, etc.) in the irradiated space must be monitored to ensure that they do not adversely impact the safety or effectiveness of the installation.

To monitor and test ultraviolet intensity, see "**Zenith**[™] UV-C Detector" in the "**Optional Accessories**" section.

UNPACKING



IN ORDER TO PERFORM THIS TASK, BE SURE TO WEAR THE FOLLOWING SAFETY EQUIPMENT: SAFETY GLASSES OR A FACE SHIELD, AS WELL AS GLOVES.

- Remove the **Hygeaire**[®] from its shipping carton.
- Atlantic Ultraviolet Corporation[®] takes all possible precautions when packaging this unit to prevent damage. Carefully inspect the unit, power cord and plug for damage and report all damage immediately. Do not assemble or operate if there is any damage, visible or suspected.
- Germicidal lamp is packed separately, to ensure maximum protection for the lamp. Keep the lamp aside until ready for installation.
- Carefully inspect all packing materials to prevent the loss of accessories, mounting hardware, spare parts or instructions.
- Do not discard packing materials until unit is assembled and start up is complete.

The **Hygeaire**[®] Model LIND30-EVO fixture includes:

- 1 - Model LIND30-EVO single lamp fixture
- 1 - **STER-L-RAY**[®] Germicidal Ultraviolet Lamp
- 1 - Operating Instructions

INSTALLATION

FIXTURE PLACEMENT

- The **Hygeaire**® fixture is recommended for use in rooms with good ventilation, with a ceiling height of 9 feet or more and where occupants remain for prolonged periods.
- Access to the room does not need to be controlled while the fixture is operating.
- The louver panels of the **Hygeaire**® fixture protects room occupants from ultraviolet exposure, by directing germicidal ultraviolet radiation into the upper areas of the room.
- Any plans for the installation of the **Hygeaire**® fixtures, should take into account the reflectance of the ceiling. Some finishes may have reflectances that are objectionably high, making exposure of more than a few hours unsafe. If any help is needed in determining the reflectance of a surface, please contact the factory.
- Ultraviolet energy, produced by the germicidal lamp, can fade some colors and/or alter the surface of some materials especially those directly irradiated by the lamp. If any help is needed in determining the ultraviolet resistance of any material, please contact the factory.
- The **Hygeaire**® LIND30-EVO fixture is designed to mount horizontally, on a vertical surface or wall at a **minimum** height of 7 feet above the floor.

SETUP INSTRUCTIONS

- The fixture is to be mounted on a plumb, vertical surface, at a **minimum** height of 7 feet above the floor. (To ensure fixture is mounted to a secure vertical surface, installation location must be able to safely support 20 pounds.)
- Remove thumbscrews and open fixture to expose interior lampholders and reflectors. (**Figure 1** Item 1)
- Remove one mounting screw from each end of the reflector so that the reflector will be able to pivot toward the lampholder. (**Figure 1** Item 2)
- Pivot reflectors, on remaining screws, to expose the rear mounting holes and 7/8-inch wire access hole. (**Figure 1** Item 3)
- All wiring should conform to state and local electrical codes as well as the current National Electrical Code (NEC).
- After mounting and wiring, pivot reflectors back into place and replace mounting screws. Install lamp following the steps in “**Lamp Installation, Replacement, or Cleaning**” in the “**Maintenance**” section.
- Close fixture and replace thumbscrews

ULTRAVIOLET OUTPUT ADJUSTMENT



IN ORDER TO PERFORM THIS TASK, BE SURE TO WEAR THE FOLLOWING SAFETY EQUIPMENT: SAFETY GLASSES OR A FACE SHIELD, AS WELL AS GLOVES.

Use an ultraviolet meter (see “**Zenith™ UV-C Detector**” in “**Optional Accessories**” section) and survey the room in which the **Hygeaire**® fixture is installed.

If after a survey of the occupied area of the room shows the germicidal ultraviolet radiant exposure of personnel is not within acceptable limits, the output of the **Hygeaire**® fixture **MUST** be adjusted. The **Surelite™** Electronic Variable Output Ballast in the **Hygeaire**® fixture controls **STER-L-RAY®** Germicidal Ultraviolet Lamp output. The remote potentiometer, used for output adjustment, is recessed in the base of the fixture. Access, to the potentiometer, is limited by a ½” ID plug which must be removed before any adjustments can be made.

1. Locate and remove protective plug. (see **Figure 2, Item 6 – Replacement parts for Model LIND30-EVO**)
2. Carefully insert a small flat bladed screwdriver, through the clearance hole in the fixture, into the slotted shaft of the potentiometer. Slowly turn the shaft until desired output is reached. Turning shaft clockwise increases output, while turning the shaft counterclockwise decreases output.
3. Replace protective plug.

PRECAUTIONS

Immediately following initial installation of the **Hygeaire**® fixture, the occupied area, of the room, should be surveyed with the **Zenith™** UV-C Detector, to ensure that the ultraviolet radiant exposure of personnel is within acceptable limits. Thereafter this procedure should be repeated whenever any maintenance is performed, including lamp changes or whenever maintenance or repairs are performed in the vicinity of the fixture. In addition, procedures should be adopted to ensure that the fixture is powered off whenever personnel are working above the 6-foot level. Personnel who work in and around the treated area should be briefed on the benefits and the precautions to be observed. (**Continued on Page 6**)

If there are any doubts or questions about the safety or the effectiveness of the installation, or if a sensitive ultraviolet meter is required, please contact the factory. (See “Zenith™ UV-C Detector” in the “Optional Accessories” section.)

INSTALLATION

Figure 1 – LIND30-EVO Installation
(Drawing Refers to “Setup Instructions” Section)

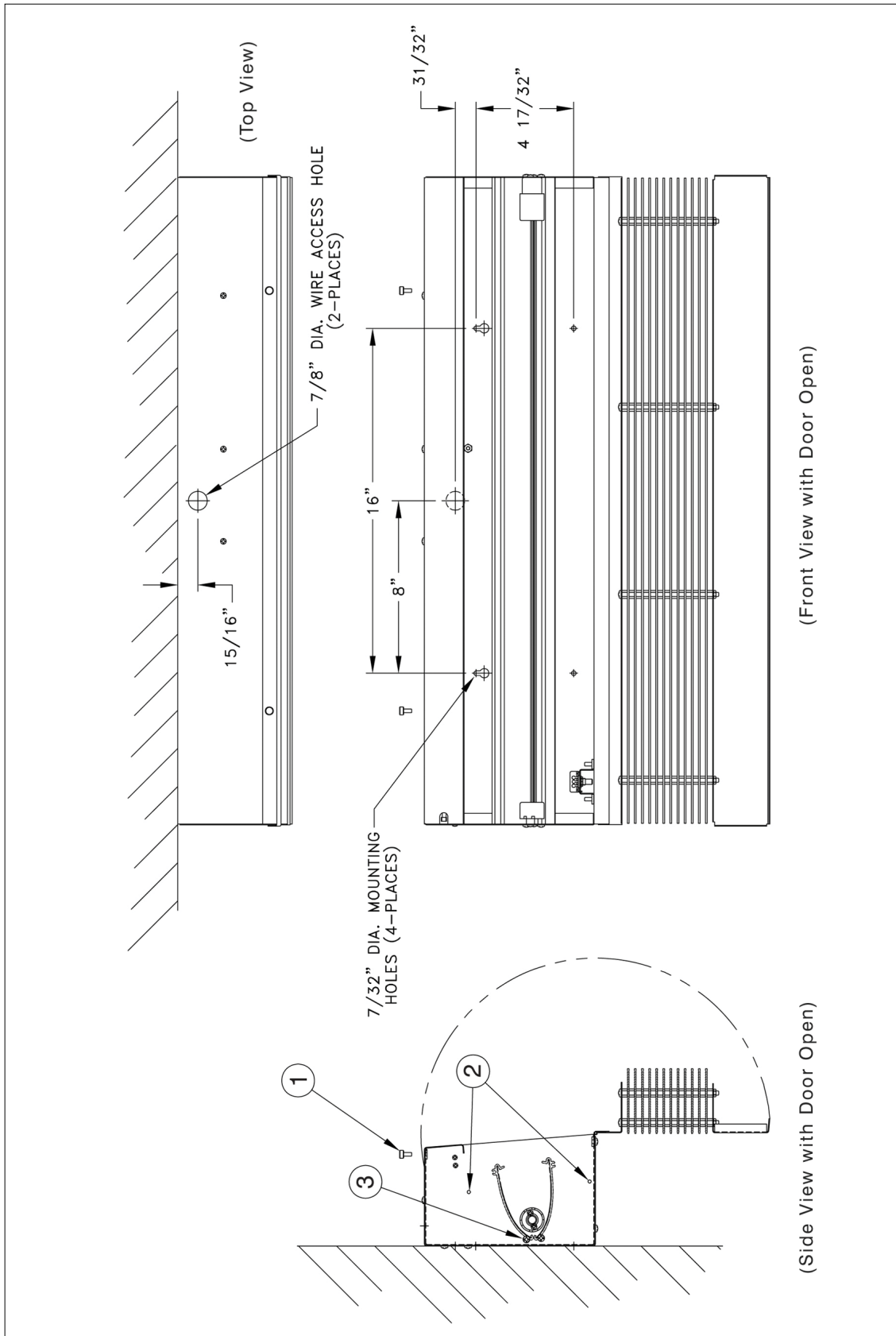

All specifications, dimensional data, etc are approximate and subject to change without notice.

MAINTENANCE



⚠ CAUTION Personal protection equipment, such as gloves; long sleeves with no gaps between cuffs and gloves, and ultraviolet resistant face shield, is **required** when entering the irradiated space, above 6 ½ feet from the floor, with the germicidal lamp operating.



⚠ WARNING **Always disconnect power to the fixture before performing any service or maintenance.** The **Hygeaire®** is equipped with a safety interlock switch that will shut down the germicidal lamp when the louver panel is opened.



⚠ CAUTION **Do not override safety interlock switch. Operation of the fixture with the override of the interlock switch and louver panel open will expose personnel to direct or strongly reflected germicidal ultraviolet rays. Germicidal ultraviolet rays are harmful to the eyes and skin.**

- The **Hygeaire®** is designed to operate with a minimal amount of maintenance. Occasional ultraviolet measurements **MUST** be made to ensure that germicidal ultraviolet intensities in the treated areas remain within the allowable exposure limits and above minimum levels.
- A regular cycle of cleaning the **STER-L-RAY®** Germicidal Lamp and interior reflectors **MUST** be established based on visual inspection and experience. The frequency of cleaning will vary with the conditions surrounding each installation. It is recommended that the **STER-L-RAY®** Germicidal Lamp and interior reflectors be cleaned at least once every three (3) months.
- The **STER-L-RAY®** Germicidal Ultraviolet Lamp used in the **Hygeaire®** fixture have a manufacturer's rated average effective life of 10,000 hours. Lamp may operate longer than rated effective life, but the reduction in ultraviolet output will make it impractical to use past the manufacturer's rated life. For maximum efficiency lamp replacement is recommended every 10,000 hours of operation or about one (1) year of continuous use.

LAMP INSTALLATION, REPLACEMENT, OR CLEANING



IN ORDER TO PERFORM THIS TASK, BE SURE TO WEAR THE FOLLOWING SAFETY EQUIPMENT: SAFETY GLASSES OR A FACE SHIELD, AS WELL AS GLOVES.



⚠ WARNING **Always disconnect power to the unit before performing any service or maintenance.**



⚠ CAUTION **Ultraviolet lamp is easily damaged and may cause injury if broken. Exercise care when handling.**

1. Shut down power to the fixture, and disconnect fixture from utility power source.
2. Open the louver panel, by removing the two (2) thumbscrews.
3. To remove **STER-L-RAY®** lamp, push the lamp to compress the spring-loaded lampholder. When the **STER-L-RAY®** lamp contact/pin clears the lampholder, angle the lamp away from fixture and pull out.
4. Moisten a clean, lint-free cloth with denatured alcohol and wipe down the outer surface of the lamp.
5. When **STER-L-RAY®** lamp has been removed and cleaned, then safely set aside, remove any loose dust or dirt from the interior of the fixture with a soft dry cloth, or vacuum. The reflector of the **Hygeaire®** is constructed from specular aluminum, a highly reflective mirror like material, used to maximize ultraviolet intensity.
6. To remove any dust, dirt, fingerprints, smears, etc, from the outer surfaces of the reflector, moisten a clean, lint-free cloth with denatured alcohol and wipe down the reflector. Buff out any streaks, left from the cleaning, using a soft dry cloth.
7. Install lamp, push the lamp to compress the spring-loaded lampholder. When the lamp contact/pin clears the lampholder, line up the contact pin on the end of the lamp with the hole in the center of the lampholder and release the lamp to allow the contact pin to seat.
8. Verify that lamp is properly seated.
9. Close fixture and replace thumbscrews.
10. Reconnect fixture to utility power, and restart fixture.



⚠ WARNING **Avoid exposure to direct or reflected germicidal ultraviolet rays. Germicidal ultraviolet rays are harmful to the eyes and skin.**

11. Verify operation by viewing lamp, use of personal protection equipment is required. If the fixture is not operating properly, go to the **“Troubleshooting”** section.

BREAKAGE

⚠ CAUTION Broken Quartz is **SHARP**.



Wear protective gloves when handling broken ultraviolet lamp(s). In the event of breakage, **DO NOT** use a household vacuum cleaner to pick up fragments of the lamp. Sweep up debris into a plastic bag and dispose of properly.

DISPOSAL OF MERCURY ADDED LAMPS



Germicidal ultraviolet lamps, like standard fluorescent lamps contain small amounts of mercury. Mercury added lamps should not be placed in the trash. Dispose of properly. For further information regarding the disposal and recycling of lamps containing mercury, along with Federal and State requirements visit LampRecycle.org. For more information on **STER-L-RAY**[®] Germicidal Ultraviolet Lamps, visit Ultraviolet.com or BuyUltraviolet.com.

TROUBLESHOOTING

⚠ WARNING Always disconnect power to the unit before performing any service or maintenance.



⚠ CAUTION Use personal protection equipment, such long sleeves with no gaps between cuffs and gloves, and ultraviolet resistant face shield, if troubleshooting **Hygeaire**[®].

IMPORTANT: This unit is to be serviced **ONLY** by qualified, and appropriately trained and/or licensed personnel.

Table 1 – Troubleshooting

Problem	Possible Cause	Corrective Action
Hygeaire [®] not operating	No electrical power	Verify that the unit is connected to a live power source.
	Power connections to fixtures, loose or disconnected	Verify power connections to fixture are fully engaged.
STER-L-RAY [®] Germicidal Lamp not operating	STER-L-RAY [®] lamp not installed	Install lamp.
	STER-L-RAY [®] Germicidal Lamp not properly seated	Confirm connection between lamp and lampholder is tight, and that lamp is making full contact with lampholder.
	STER-L-RAY [®] Germicidal Lamp faulty	Swap suspect lamp, with known good. If known good lamp does not operate, replace ballast.
	Surelite [™] Ballast not functioning	Locate ballast and replace.
	Interlock Switch open	Confirm louver panel is closed and secured.
	Interlock Switch faulty	Replace Interlock Switch.

If the above measures fail to correct the problem(s), contact our Application Specialists. Contact options can be found in the “User Assistance” section of this manual, located on the back page.

TECHNICAL SPECIFICATIONS

Table 2 – Technical Data

Model		LIND30-EVO
Dimensions:	Length:	30”
	Width:	5-3/8”
	Height:	8-5/16”
Electrical:	Volts:	220–240v*
	Amps (Max):	0.29A
	Frequency:	50/60Hz
	Lamp Watts: ①	32 Watts
Total Ultraviolet Output: ②		11 Watts

All specification, dimensional data etc. are approximate and subject to change without notice.

*Consult factory for voltages other than 220v.

① Wattage is lamp watts only and does not include ballast loss.

② Ultraviolet output at 254nm at 100 hours and 80 °F (approximate).

REPLACEMENT PARTS

Figure 2 – Replacement Parts for Model LIND30-EVO

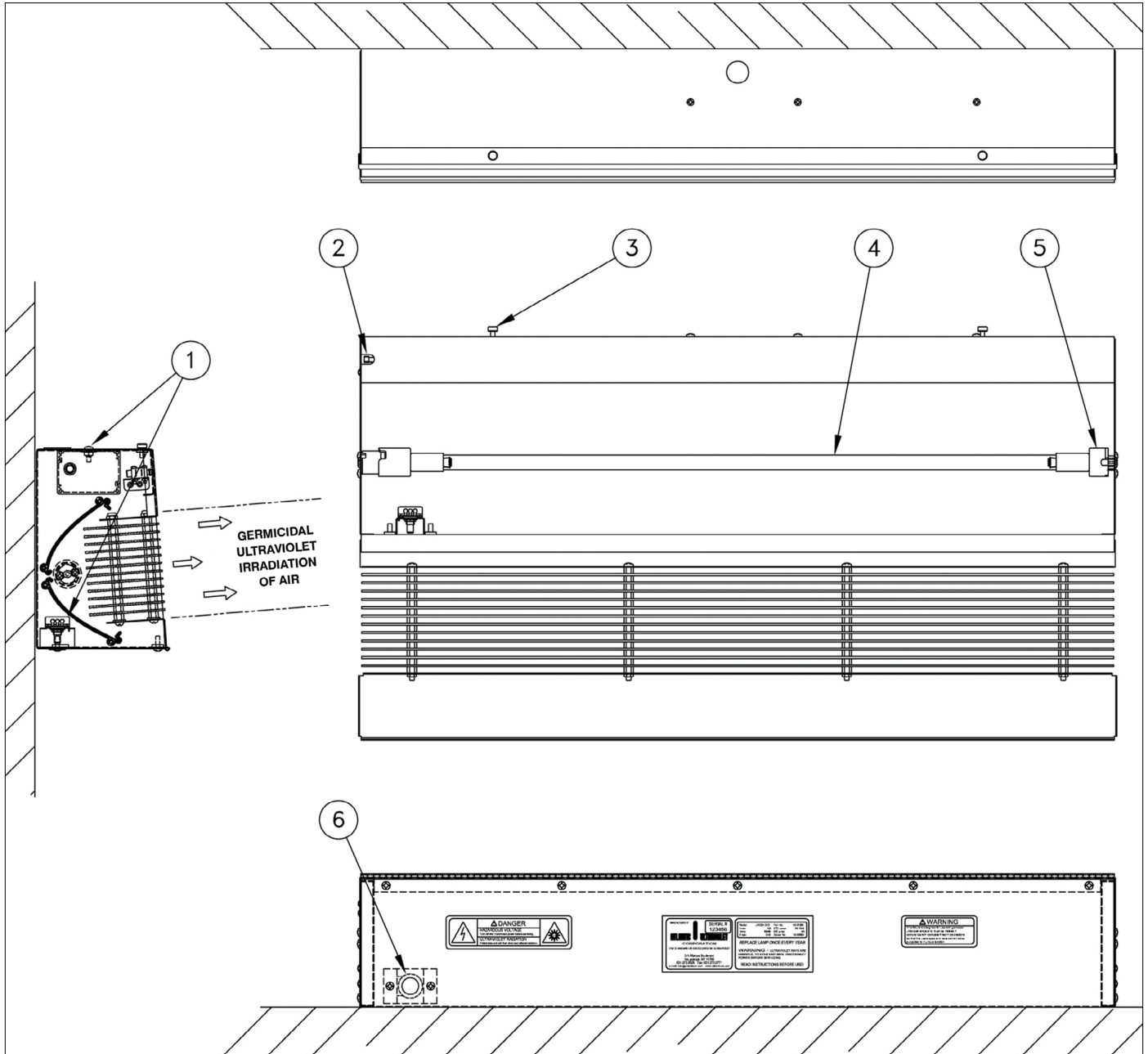

All specifications, dimensional data, etc are approximate and subject to change without notice.

Table 3 – Replacement Parts for Model LIND30-EVO

Item No.	Description	Quantity	Part No.
1	Surelite™ Electronic Variable Output Ballast, 220-240v 50/60Hz	1	10-0055B
2	Safety Interlock Switch Assembly	1	40-4040A
3	Thumbscrew, 8-32 x 3/8" Lg	2	50-0080
4	STER-L-RAY® Germicidal Ultraviolet Lamp	1	05-1352-R
5	Steadfast™ Lampholder Set	1	05-1320A-R
6	Plug, 1/2" ID	1	00-0027

Other replacement parts are available. Consult the factory for specific requirements.
All specifications, dimensional data, etc. are approximate and subject to change without notice.

OPTIONAL ACCESSORIES

1. **Zenith™ UV-C Detector:** A sensitive, hand-held, self-contained battery operated ultraviolet meter that can be used for:
 - Monitoring UV-C Germicidal Lamp Intensity & Aging
 - Measuring UV-C Germicidal Fixture Leakage
2. **Promate™ Safety Glasses:** Safety eyewear **MUST** be used as general-purpose safety protection and for additional shielding from ultraviolet rays
3. **Promate™ Face Shield:** Lightweight visor with adjustable headgear provides eye and face protection from germicidal ultraviolet rays

For more information and purchasing contact our offices, weekdays between 8:30 am and 5:00 pm Eastern time, at:
Atlantic Ultraviolet Corporation®, 375 Marcus Boulevard, Hauppauge, New York, 11788
Tel: 631.273.0500 • Fax: 631.273.0771 • Email: Sales@AtlanticUV.com • Website: Ultraviolet.com – BuyUltraviolet.com

MAINTENANCE NOTES

MAINTENANCE NOTES

USER ASSISTANCE

Atlantic Ultraviolet Corporation® makes every effort to ensure that the **Hygeaire®** Indirect Germicidal Ultraviolet Air Disinfection Fixtures are products of superior quality and workmanship. This manual describes the installation, operation and maintenance of the **Hygeaire®** Indirect Germicidal Ultraviolet Air Disinfection Fixture.

Please read and become familiar with the contents of this manual before installing or using this unit. If after reading the manual you still have questions, or concerns, regarding the installation or use of this unit, contact our offices, weekdays between 8:30 am and 5:00 pm Eastern Time, at:

Atlantic Ultraviolet Corporation®
375 Marcus Boulevard
Hauppauge, New York, 11788
Tel: 631.273.0500
Fax: 631.273.0771
Email: Sales@AtlanticUV.com
Website: Ultraviolet.com
BuyUltraviolet.com

PATENT NOTICE

No attempt has been made to determine the patent status of applications illustrated or described in this publication. Inclusion in this publication of any design or method of use, which may be patented, is not to be construed as promoting or sanctioning unauthorized use.

WARRANTY & PRODUCT REGISTRATION

We warrant this product to the original owner to be free from defects in material and workmanship when installed in accordance with Atlantic Ultraviolet Corporation® specifications for a period of time as follows:

UV Water Purifier Chambers – Type 316 stainless steel chambers will have a Twelve (12) year Limited Warranty on the stainless steel chamber, from the date of original purchase while the Type 304 stainless steel chambers will have a Six (6) year Limited Warranty on the stainless steel chamber.

UV Air Disinfection Housing – Three (3) year Limited Warranty on the metal housing, from the date of original purchase.

Ballasts – Three (3) year Limited Warranty, from the date of original purchase.

UV Lamps, Monitoring Devices, Optional Accessories, and Other Parts – One (1) year Limited Warranty from the date of original purchase.

Within the warranty period we shall repair or replace such products, which are returned to us with shipping charges prepaid and which are determined by us to be defective. This warranty will not apply to any product, which has been subjected to misuse, negligence or accident; or misapplied; or modified; or repaired by unauthorized person; or improperly installed. Warranty will be null and void if any of the product's original labels are removed. This Limited warranty excludes the cost of labor.

The Buyer shall inspect the product promptly after receipt and shall notify us at our main office in writing of claims, including claims of breach of warranty, within thirty (30) days after the Buyer discovers or should have discovered the facts upon which the claim is based. Failure of the Buyer to give written notice of a claim within the time period shall be deemed to be a waiver of such claim.

The provisions of the above warranty are our sole obligation and exclude all other remedies or warranties, expressed or implied, including warranties of merchantability and fitness for a particular purpose, whether or not purposes or specifications are described herein. We further disclaim any responsibility whatsoever to the customer, or to any person for injury to person, damage to, or loss of property or value caused by any product which has been subjected to misuse, negligence, accident; or modified or repaired by unauthorized persons; or improperly installed.

Under no circumstances shall the Company be liable for any incidental, consequential or special damages; losses or expenses arising from the contract for this product, or in connection with the use of, or inability to use, our product for any purpose whatsoever.

Be sure to register your product and validate purchase within 30 days — registration is simple and will take less than 2 minutes to do.

NOTE – failure to register your purchase may jeopardize warranty.

Go to Ultraviolet.com and scroll down to the bottom of the page, under “Trust” click the “Warranty Registration Form”, complete and click “Submit”. Or click on “Warranty Registration PDF” to download the warranty registration card as a PDF, complete and mail to us at 375 Marcus Boulevard, Hauppauge, NY 11788, or simply fax to 631-273-0771. If you prefer to register by phone, please call 631-273-0500 and our customer service staff will be glad to assist you.

For your convenience, record the following information below. The model and serial number can be found on a label located on the **Hygeaire®** Indirect Germicidal Ultraviolet Air Disinfection Fixture. Keep this manual, along with proof of purchase, handy when contacting our offices.

Purchased From:	Date:
Model:	Serial No.: